



F420001 200Vdc External Voltage Bias Fixture

Terminal Connector:	4-Terminal Pair, BNC
DUT Connection:	4-Terminal
Dimensions (approx.):	150x97x145 (W/H/D)
Weight (approx.):	829g
Applicable Instruments:	6365, 6370 ~ 6379
Frequency:	100 Hz to 1 MHz
Maximum Voltage:	±200 V peak max. (AC+DC)
Operating Temperature:	0°C to 55°C



F423501 Kelvin Clip Leads

Terminal Connector:	4-Terminal Pair, BNC
DUT Connection:	4-Terminal
Cable Length(approx.):	0.7m (RG174)
Weight (approx.):	124g
Applicable Instruments:	6365, 6370 ~ 6379
Frequency:	DC to 1 MHz
Maximum Voltage:	±42 V peak max. (AC+DC)
Operating Temperature:	0°C to 55°C
DUT Size:	See below figure

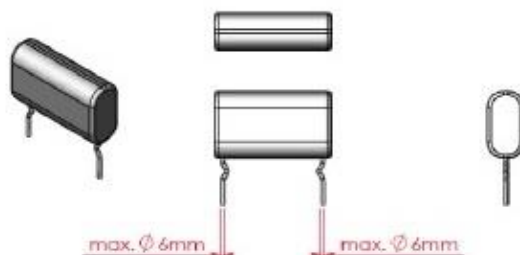



F423502 Kelvin Clip Leads (BNC Box)

Terminal Connector:	4-Terminal Pair, BNC
DUT Connection:	4-Terminal
Cable Length (approx.):	0.8m (RG174)
Weight (approx.):	170g
Applicable Instruments:	6365, 6370 ~ 6379
Frequency:	DC to 1 MHz
Maximum Voltage:	±42 V peak max. (AC+DC)
Operating Temperature:	0°C to 55°C
DUT Size:	See below figure

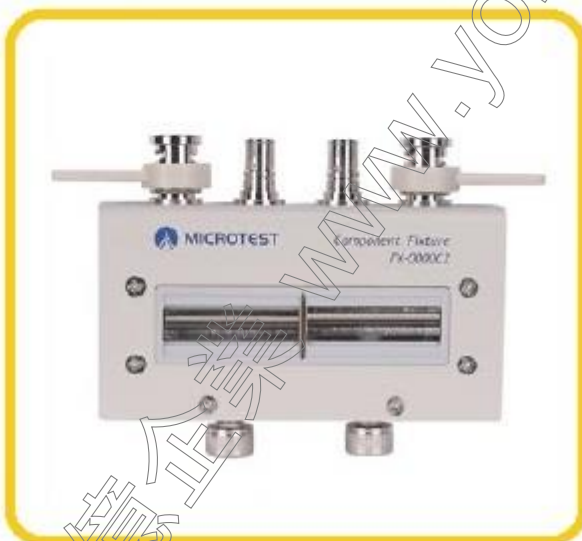
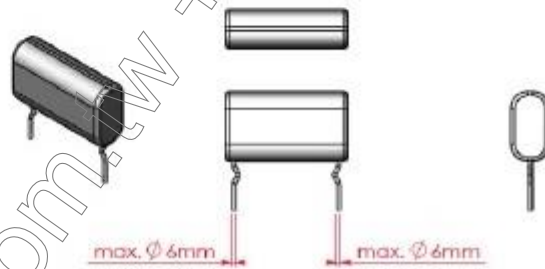

F423503 DIP Test Fixture

Terminal Connector:	4-Terminal Pair, BNC
DUT Connection:	4-Terminal
Dimensions (approx.):	105x25x68mm (W/H/D)
Weight (approx.):	152g
Applicable Instruments:	6365, 6370 ~ 6379
Frequency:	DC to 10 MHz
Maximum Voltage:	±42 V peak max. (AC+DC)
Operating Temperature:	0°C to 55°C
DUT Size:	See below figure

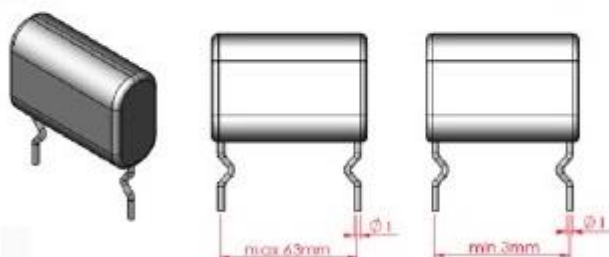



F423504 DIP Test Fixture

Terminal Connector:	4-Terminal Pair, BNC
DUT Connection:	4-Terminal
Cable Length(approx.):	1.2m (RG174)
Weight (approx.):	905g
Applicable Instruments:	6365, 6370 ~ 6379
Frequency:	DC to 1 MHz
Maximum Voltage:	±42 V peak max. (AC+DC)
Operating Temperature:	0°C to 55°C
DUT Size:	See below figure

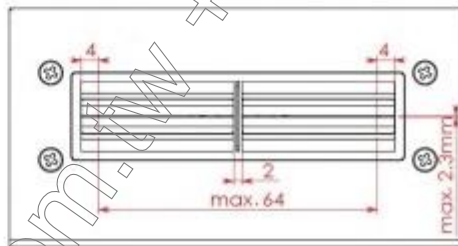

(Unit:mm)



F423901 Kelvin Clip Leads

Terminal Connector:	4-Terminal Pair, BNC
DUT Connection:	4-Terminal
Cable Length(approx.):	0.7m (RG178)
Weight (approx.):	110g
Applicable Instruments:	6365, 6370 ~ 6379
Frequency:	DC to 1 MHz
Maximum Voltage:	±42 V peak max. (AC+DC)
Operating Temperature:	0°C to 55°C
DUT Size:	See below figure

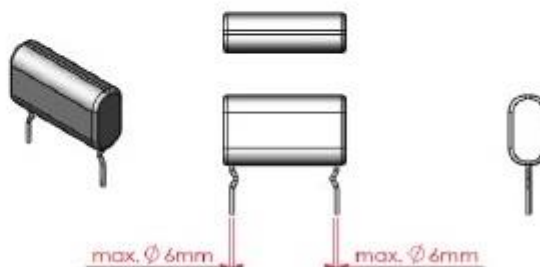

max. ϕ 6mm

max. ϕ 6mm



F423902 Kelvin Clip Leads (BNC Box)

Terminal Connector:	4-Terminal Pair, BNC
DUT Connection:	4-Terminal
Cable Length(approx.):	0.8m (RG178)
Weight (approx.):	170g
Applicable Instruments:	6365, 6370 ~ 6379
Frequency:	DC to 1 MHz
Maximum Voltage:	±42 V peak max. (AC+DC)
Operating Temperature:	0°C to 55°C
DUT Size:	See below figure

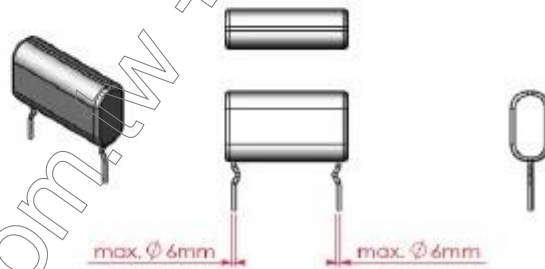

F423903 SMD Tweezers Test Leads (BNC Box)

Terminal Connector:	4-Terminal Pair, BNC
DUT Connection:	2-Terminal
Cable Length(approx.):	1.5m (RG178)
Weight (approx.):	195g
Applicable Instruments:	6365, 6370 ~ 6379
Frequency:	DC to 1 MHz
Maximum Voltage:	±42 V peak max. (AC+DC)
Operating Temperature:	0°C to 55°C
DUT Size:	≤ 12mm





F423904 SMD Tweezers Test Leads

Terminal Connector:	4-Terminal Pair, BNC
DUT Connection:	2-Terminal
Cable Length(approx.):	1.5m (RG178)
Weight (approx.):	131g
Applicable Instruments:	6365, 6370 ~ 6379
Frequency:	DC to 1MHz
Maximum Voltage:	±42 V peak max. (AC+DC)
Operating Temperature:	0°C to 55°C
DUT Size:	≤ 12mm



F423905 SMD Test Fixture

Terminal Connector:	4-Terminal Pair, BNC
DUT Connection:	2-Terminal
Dimensions (approx.):	118x48x52mm (W/H/D)
Weight (approx.):	235g
Applicable Instruments:	6365, 6370 ~ 6379
Frequency:	DC to 10 MHz
Maximum Voltage:	±42 V peak max. (AC+DC)
Operating Temperature:	0°C to 55°C
DUT Size:	See below figure

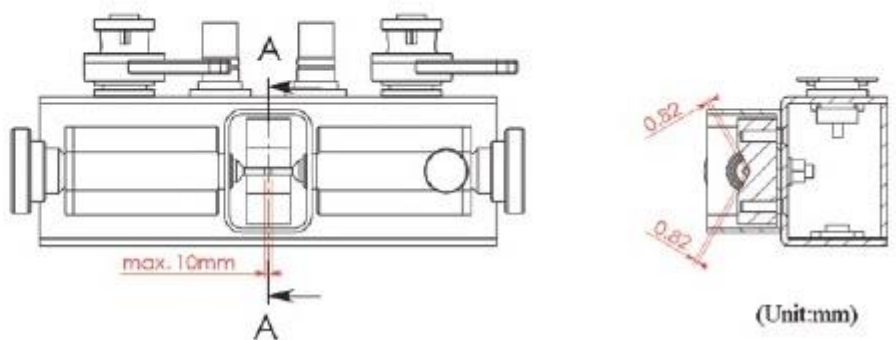



F423906A Kelvin Clip Leads (BNC Box)

Terminal Connector:	4-Terminal Pair, BNC
DUT Connection:	4-Terminal
Cable Length(approx.):	1m (RG174)
Weight (approx.):	178g
Applicable Instruments:	6630, 6365, 6370 ~ 6379
Frequency:	DC to 1 MHz
Maximum Voltage:	±42 V peak max. (AC+DC)
Operating Temperature:	0°C to 55°C
DUT Size:	See below figure

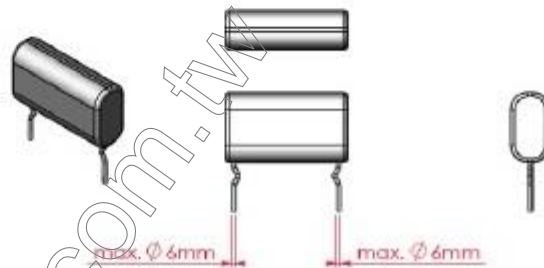

F663001A/B/C BNC Test Leads

Terminal Connector:	4-Terminal Pair, BNC
DUT Connection:	4-Terminal
Cable Length(approx.):	0.5m/1m/2m (A/B/C, RG174)
Weight (approx.):	197g/224g/276g
Applicable Instruments:	6630 , 6365, 6370 ~ 6379
Frequency:	DC to 20MHz/10MHz/5MHz (A/B/C)
Maximum Voltage:	±42 V peak max. (AC+DC)
Operating Temperature:	0°C to 55°C



FX-0000C6 Test Fixture

Terminal Connector:	4-Terminal Pair, BNC
DUT Connection:	4-Terminal
Dimensions (approx.):	98x25x65mm (W/H/D)
Weight (approx.):	246g
Applicable Instruments:	6630, 6365, 6370~6379
Frequency:	DC to 30 MHz
Maximum Voltage:	±42 V peak max. (AC+DC)
Operating Temperature:	0°C to 55°C
DUT Size:	See below figure

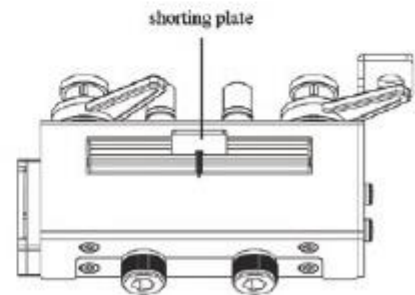
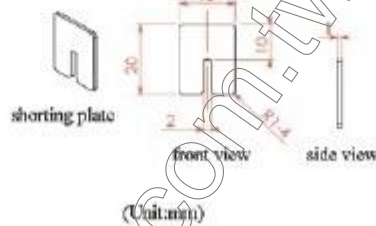
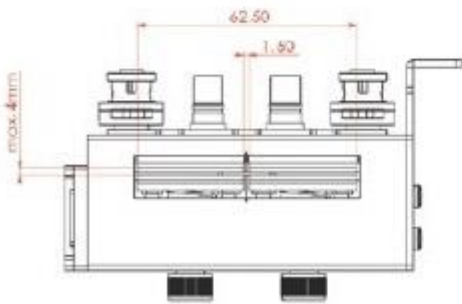

FX-0000C7 Dielectric Material Test Fixture

Terminal Connector:	4-Terminal Pair, BNC
DUT Connection:	2-Terminal
Dimensions (approx.):	115x155x126mm (W/H/D)
Weight (approx.):	827g
Applicable Instruments:	6630
Frequency:	≤ 30 MHz
Maximum Voltage:	±42 V peak max. (AC+DC)
Operating Temperature:	0°C to 55°C
Electrode Diameter:	38mm (Type A), 5mm (Type B)
DUT Thickness:	≤ 10mm



FX-0000C8 Magnetic Material Test Fixture

Terminal Connector:	4-Terminal Pair, BNC
Dimensions (approx.):	105x125x65mm (W/H/D)
Weight (approx.):	738g
Applicable Instruments:	6630
Frequency:	≤ 30 MHz
Maximum Voltage:	±42 V peak max. (AC+DC)
Operating Temperature:	0°C to 55°C
DUT Size:	Type A: OD 8, ID 3.1, H 3 mm Type B: OD 20.5, ID 4.8, H 11 mm Type C: OD 65.5, ID 7.1, H 28 mm



FX-0000C9 Test Fixture

Terminal Connector:	4-Terminal Pair, BNC
DUT Connection:	2-Terminal
Dimensions (approx.):	115x135x126mm (W/H/D)
Weight (approx.):	651g
Applicable Instruments:	6630, 6365, 6370~6379
Frequency:	DC to 30 MHz
Maximum Voltage:	±42 V peak max. (AC+DC)
Operating Temperature:	0°C to 55°C
DUT Thickness:	≤ 10mm

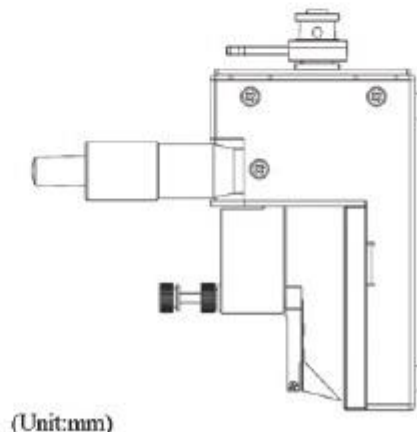
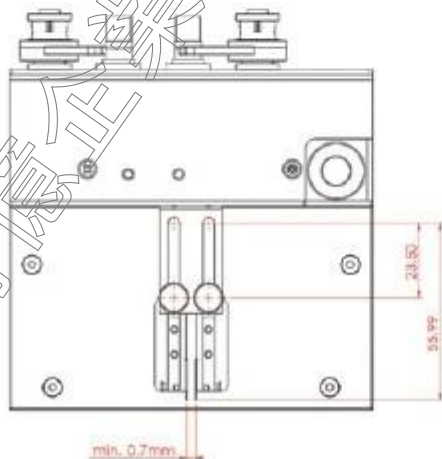



FX-000C10 Bottom Electrode SMD Test Fixture

Terminal Connector:	4-Terminal Pair, BNC
DUT Connection:	2-Terminal
Dimensions (approx.):	91x80x98mm (W/H/D)
Weight (approx.):	237g
Applicable Instruments:	6630, 6365, 6370~6379
Frequency:	DC to 30 MHz
Maximum Voltage:	±42 V peak max. (AC+DC)
Operating Temperature:	0°C to 55°C
DUT Size:	≤ 9x9x5mm (W/H/D)



FX-000C11 SMD Tweezers Test Leads

Terminal Connector:	4-Terminal Pair, BNC
DUT Connection:	2-Terminal
Cable Length(approx.):	1m (RG178)
Weight (approx.):	170g
Applicable Instruments:	6630, 6365, 6370~6379
Frequency:	DC to 10 MHz
Maximum Voltage:	±42 V peak max. (AC+DC)
Operating Temperature:	0°C to 55°C
DUT Size:	≤ 10mm





FX-000C12 SMD Test Fixture

Terminal Connector:	4-Terminal Pair, BNC
DUT Connection:	2-Terminal
Dimensions (approx.):	91x42x57mm (W/H/D)
Weight (approx.):	148g
Applicable Instruments:	6630, 6365, 6370~6379
Frequency:	DC to 30 MHz
Maximum Voltage:	±42 V peak max. (AC+DC)
Operating Temperature:	0°C to 55°C
DUT Size:	≤ 7mm

